

KARBİR®

PLASTİK

2020
ÜRÜN KATALOĐU
PRODUCT CATALOGUE

www.karbir.com.tr

KARBİR[®]
P L A S T İ K 

SINCE 1996

İNDEKS / INDEX

YAĞMURLAMA BAŞLIKLARI

Rotating Sprinkler

01 - 12

YAĞMURLAMA ve EK PARÇALARI

SPRINKLER FITTINGS

UZATMA BORULARI

EXTENSION PIPES

MİNİ SPRİNK SİSTEMİ

MINI SPRINKLER SYSTEM

HAT VANALARI

LINE VALVES

DAMLAMA SULAMA EK PARÇALARI

DRIP IRRIGATION FITTINGS

FİLTRASYON

FILTRATION

METAL EK PARÇALARI

METAL FITTINGS

BÖLGE SATIŞ TEMSİLCİLERİ

REGIONAL SALES REPRESENTATIVES

BORU ÇAPINA GÖRE SPRİNK HESAPLAMA TABLOSU

SPRINK CALCULATION TABLE BY PIPE DIAMETER

SİSTEM HESAPLAMA TABLOSU

SYSTEM CALCULATION TABLE

YÜKLEME DETAYLARI

LOADING DETAILS

HAKKIMIZDA

Üretim faaliyetlerine 1996 yılında bir adet extruder makinesiyle başlayan **KARBİR PLASTİK** , KARBİR PVC BORU PROFİL SANAYİ TİC. AŞ. yi kurmuş 2008 yılında ise unvan değişikliği yaparak **KARBİR MAKİNA NAKLİYAT İNŞAAT ve PLASTİK SAN.TİC.LTD.ŞTİ** adını almıştır.Günümüzde faaliyet gösterdiği sektörde ürün çeşitliliğini artırarak gelişen teknoloji paralelinde kaliteli ve kusursuz bir hizmet anlayışı ile üretim ve satış yapmaya devam etmektedir. Sürekli gelişme ve başarıyı amaçlayan bir takım ruhu ile; gelişen teknolojiyi takip etmeka suretiyle kaliteli ve kusursuz bir hizmet anlayışını benimseyen Karbir Plastik, sadece imalat ve satış aşamasında kalmadan daimi memnuniyetimiz için desteğinizle hep yanınızda olduk ve aynı bilinçle olmaya da devam edeceğiz.

MİSYON

Tüm süreçlerimizde sürekli iyileştirme doğrultusunda tüm çalışanlarımıza kalite bilincini yerleştirmek. Teknolojiyi takip ederek müşterilerimize kaliteli ürünler sunmak, Hayatın ihtiyaçları yönlendirmesinin mümkün olmadığı bu yüzyılda ihtiyaçların hayatı yönlendirdiği ilkesini benimseyen bir firma oluşturmak. Güven ve Kalite en üst düzeyde tutarak faaliyette bulunduğumuz sektörde varlığını devam ettirmek. Her zaman dürüst ve şeffaf bir ticaret anlayışını benimseyerek sektörde öncü bir firma olmak. Yönetim olarak, müşteri odaklı yaklaşımla çalışanlarımız ve tedarikçilerimizle gerekli standartlara ve yönetmeliklere uygun üretim yapmak,

VİZYON

BÜYÜMEK Faaliyet gösterdiği sektörde marka bilinirliğinin artırılması. Faaliyet gösterdiği sektördeki hem yurt içi hem yurt dışı Pazar payını artırmak. **REKABETÇİ OLMA** Rekabet ettiği diğer Pazar ortağı firmalara varlığını hissettirmek ve saygısını kazanmak. **Güven**, kaliteyi ön planda tutarak faaliyetlerde bulunduğumuz sektörde örnek olmak. **MÜŞTERİ ODAKLI ÇALIŞMA** Müşteri odaklı yapılanma. Yüksek müşteri memnuniyeti.

ABOUT US

Started its production activities with one extruder machine in 1996, KARBİR PLASTIC has established KARBİR PVC PIPE PROFILE INDUSTRY AND TRADE INC. and, in 2008, it changed its name and took the name of KARBİR MACHINE TRANSPORT CONSTRUCTION and PLASTIC INDUSTRY AND TRADE INC. Nowadays, it continues to make production and sales with an understanding of quality and perfect service in parallel with the developing technology by increasing its product range in the sector in which it carries out its activities. With a team spirit aiming at continuous development and success; we, Karbir Plastic, which adopts an understanding of quality and perfect service by way of following the developing technology, have always been beside you for your permanent satisfaction by moving beyond the production and sales and will do continue to do so with the same consciousness.

MISSION

To create a quality awareness in our employees in line with the continuous improvement in all our processes. To offer quality products to our customers by following the technology. To create a firm adopting the principle dictating that the needs direct the life in a century in which the vice versa is not possible. To continue its presence in the sector in which it continues its activities by giving the utmost importance to the values of trust and quality. To be a pioneering firm in the sector by always adopting an understanding of honest and transparent trade. As the management; to make production in accordance with the necessary standards and regulations together with our employees and suppliers.

VISION

GROWTH - to increase the brand awareness in the sector in which it carries out its activities. To increase its market share both at home and abroad in the sector in which it carries out its activities. **COMPETITIVENESS** - to make its presence felt by the other rival firms in the same market and gain their respect. To be an exemplary firm in our sector by giving the particular importance to the values of trust and quality. **CUSTOMER-ORIENTED ACTIVITY** - customer-oriented structuring. High customer satisfaction.

YAĞMURLAMA
BAŞLIKLARI
ROTATING SPRINKLER



Özellikler



3/4 Erkek Bağlantı
360° Tam Dairesel Hareket
Paslanmaz Çelik Yay ve Mil
Kendi Üzerinde 7 Farklı Debi Ayarı
Homojen Dağılım
Suyu Toz Halinde Dağıtma Özelliği
Tikinmeyen Yargılı Nozullar

Properties



3/4 Male Connection
360° Full Circular Motion
Stainless Steel Bow And Shapt
Homogenous Distribution
Extent Different Options Nozzle
Distributes Water Dust
Nozzle And Crusher Adjustable Sprinks Head



DEBİ AYARLI
NOZUL



Ürün Kodu Product Code	Ölçü Size (mm)	Ambalaj Miktarı Packing Quantity	Koli Tipi Box Type	Fiyat Price ₺
ATAK	3/4	50	A-1	15.46

TEKNİK ÖZELLİKLER / TECHNICAL DATA

Nozul Nozzle	2 Bar		3 Bar	
	Debi Flowrate	Mesafe Distance	Debi Flowrate	Mesafe Distance
mm	m ³ /h	mt	m ³ /h	mt
5.0x4.2	2.10	13	2.25	14
5.0x3.8	1.90	13	2.00	14
5.0x2.5	1.70	13	1.80	14
4.5x4.2	2.00	12	2.10	13
4.5x3.8	1.85	12	1.95	13
4.5x2.5	1.60	12	1.70	13
3.8x3.8	1.65	11.5	1.75	12
3.8x2.5	1.45	11.5	1.60	12



5.0-4.5



4.2-3.8



4.5-3.8



3.8-2.5

K - ATAK / K- ATAK



Özellikler



3/4 Erkek Bağlantı
360° Tam Dairesel Hareket
Paslanmaz Çelik Yay ve Mil
Kendi Üzerinde 7 Farklı Debi Ayarı
Homojen Dağılım
Suyu Toz Halinde Dağıtma Özelliği
Tıkanmayan Yargılı Nozullar

Properties



3/4 Male Connection
360° Full Circular Motion
Stainless Steel Bow And Shapt
Homogenous Distribution
Extent Different Options Nozzle
Distributes Water Dust
Nozzle And Crusher Adjustable Sprinks Head

AYARLANABİLİR
ROTAR KIRICI



Ürün Kodu Product Code	Ölçü Size (mm)	Ambalaj Miktarı Packing Quantity	Koli Tipi Box Type	Fiyat Price ₺
K - ATAK	3/4	50	A-1	15.46

TEKNİK ÖZELLİKLER / TECHNICAL DATA

Nozul Nozzle	2 Bar		3 Bar	
	Debi Flowrate	Mesafe Distance	Debi Flowrate	Mesafe Distance
mm	m ³ /h	mt	m ³ /h	mt
5.0x4.2	2.10	13	2.25	14
5.0x3.8	1.90	13	2.00	14
5.0x2.5	1.70	13	1.80	14
4.5x4.2	2.00	12	2.10	13
4.5x3.8	1.85	12	1.95	13
4.5x2.5	1.60	12	1.70	13
3.8x3.8	1.65	11.5	1.75	12
3.8x2.5	1.45	11.5	1.60	12



5.0-4.5



4.2-3.8



4.5-3.8



3.8-2.5

SK - 45 TURBO / SK - 45 TURBO



Özellikler



3/4 Erkek Bağlantı
360° Tam Dairesel Hareket
Paslanmaz Çelik Yay ve Mil
Homojen Dağılım
Suyu Toz Halinde Dağıtma Özelliği
Tıkmayan Yargılı Nozullar



Properties



3/4 Male Connection
360° Full Circular Motion
Stainless Steel Bow And Shapt
Homogenous Distribution
Extent Different Options Nozzle
Distributes Water Dust
Nozzle And Crusher Adjustable Sprinks Head

Ürün Kodu Product Code	Ölçü Size (mm)	Ambalaj Miktarı Packing Quantity	Koli Tipi Box Type	Fiyat Price ₺
SK-45 T 5X2	3/4"	50	A-1	14.83
SK-45 T 4X2	3/4"	50	A-1	14.83
SK-45 T 3X2	3/4"	50	A-1	14.83

TEKNİK ÖZELLİKLER / TECHNICAL DATA

Nozul Nozzle	1,5 Bar		2 Bar		3 Bar	
	Debi Flowrare m ³ /h	Mesafe Distance mt	Debi Flowrare m ³ /h	Mesafe Distance mt	Debi Flowrare m ³ /h	Mesafe Distance mt
5 x 2.5	1.650	12	1.735	13	1.800	14
4.2 x 2.5	1.474	10	1.541	11	1.608	12
3.8 x 2.5	1.386	9	1.449	10	1.512	11



5.0



4.2



3.8



2.5

SK - 45 / SK - 45



Özellikler



3/4 Erkek Bağlantı
360° Tam Dairesel Hareket
Paslanmaz Çelik Yay ve Mil
Homojen Dağılım
Suyu Toz Halinde Dağıtma Özelliği
Nozul ve Kırıcı Ayarlı

Properties



3/4 Male Connection
360° Full Circular Motion
Stainless Steel Bow And Shapt
Homogenous Distribution
Extent Different Options Nozzle
Distributes Water Dust

Ürün Kodu Product Code	Ölçü Size (mm)	Ambalaj Miktarı Packing Quantity	Koli Tipi Box Type	Fiyat Price ₺
SK-45 5X4	3/4"	50	A-1	14.04
SK-45 4X3	3/4"	50	A-1	14.04
SK-45 3X2	3/4"	50	A-1	14.04

TEKNİK ÖZELLİKLER / TECHNICAL DATA

Nozul Nozzle	1,5 Bar		2 Bar		3 Bar	
	Debi Flowrate m ³ /h	Mesafe Distance mt	Debi Flowrate m ³ /h	Mesafe Distance mt	Debi Flowrate m ³ /h	Mesafe Distance mt
5.0 x 4.2	2.024	12	2.116	13	2.208	14
4.2 x 3.8	1.760	10	1.840	11	1.920	12
3.8 x 2.5	1.386	9	1.449	10	1.512	11



5.0



4.2



3.8



2.5



3.8



4.2



Özellikler



3/4 Erkek Bağlantı
360° Tam Dairesel Hareket
Paslanmaz Çelik Yay ve Mil
Homojen Dağılım
Suyu Toz Halinde Dağıtma Özelliği
Nozul ve Kırıcı Ayarlı

Properties



3/4 Male Connection
360° Full Circular Motion
Stainless Steel Bow And Shapt
Homogenous Distribution
Extent Different Options Nozzle
Distributes Water Dust

Ürün Kodu Product Code	Ölçü Size (mm)	Ambalaj Miktarı Packing Quantity	Koli Tipi Box Type	Fiyat Price ₺
G - 30 4X3	3/4"	50	A-1	16.69
G - 30 5X5	3/4"	50	A-1	16.69
G - 30 5X4	3/4"	50	A-1	16.69
G - 30 6X4	3/4"	50	A-1	16.69
G - 30 6X5	3/4"	50	A-1	16.69

TEKNİK ÖZELLİKLER / TECHNICAL DATA

Nozul Nozzle mm	1,5 Bar		2 Bar		3 Bar	
	Debi Flowrare m ³ /h	Mesafe Distance mt	Debi Flowrare m ³ /h	Mesafe Distance mt	Debi Flowrare m ³ /h	Mesafe Distance mt
6.0 x 5.0	2.40	14	2.50	14	2.60	16
6.0 x 4.2	2.24	14	2.35	14	2.45	16
5.0 x 5.0	2.10	12	2.30	12	2.50	14
5.0 x 4.2	2.00	11	2.12	12	2.21	14



4.2-3.8

6.0-5.0-4.2

G-30 TURBO / G-30 TURBO



Özellikler



3/4 Erkek Bağlantı
360° Tam Dairesel Hareket
Paslanmaz Çelik Yay ve Mil
Homojen Dağılım
Suyu Toz Halinde Dağıtma Özelliği
Nozul ve Kırıcı Ayarlı

Properties



3/4 Male Connection
360° Full Circular Motion
Stainless Steel Bow And Shapt
Homogenous Distribution
Extent Different Options Nozzle
Distributes Water Dust



Ürün Kodu Product Code	Ölçü Size (mm)	Ambalaj Miktarı Packing Quantity	Koli Tipi Box Type	Fiyat Price ₺
G - 30 T 4X3	3/4"	50	A-1	19.50
G - 30 T 5X4	3/4"	50	A-1	19.50
G - 30 T 6X3	3/4"	50	A-1	19.50
G - 30 T 6X4	3/4"	50	A-1	19.50

TEKNİK ÖZELLİKLER / TECHNICAL DATA

Nozul Nozzle	1,5 Bar		2 Bar		3 Bar	
	Debi Flowrate	Mesafe Distance	Debi Flowrate	Mesafe Distance	Debi Flowrate	Mesafe Distance
mm	m ³ /h	mt	m ³ /h	mt	m ³ /h	mt
6.0 x 4.2	2.24	14	2.35	15	2.45	16
6.0 x 3.8	2.15	14	2.25	15	2.35	16
5.0 x 4.2	2.02	12	2.12	13	2.21	14
4.2 x 3.8	1.70	9	1.80	10	1.90	11



4.2-3.8



6.0-5.0-4.2

A-42 / A-42



Özellikler



3/4 Erkek Bağlantı
Belirlenen Ağırlardan Sulama Özelliği
Paslanmaz Çelik Yay ve Mil
Homojen Dağılım
Suyu Toz Halinde Dağıtma Özelliği
Nozul ve Kırıcı Ayarlı

Properties



3/4 Male Connection
At The Specified Opening Irrigation Feature
Stainless Steel Bow And Shapt
Homogenous Distribution
Extent Different Options Nozzle
Distributes Water Dust

Ürün Kodu Product Code	Ölçü Size (mm)	Ambalaj Miktarı Packing Quantity	Koli Tipi Box Type	Fiyat Price ₺
A - 45 5	3/4"	50	A-1	21.80
A - 45 4	3/4"	50	A-1	21.80

TEKNİK ÖZELLİKLER / TECHNICAL DATA

Nozul Nozzle	2 Bar		3 Bar	
	Debi Flowrate	Mesafe Distance	Debi Flowrate	Mesafe Distance
mm	m ³ /h	mt	m ³ /h	mt
5	1.200	12	1.300	13
4.2	1.00	12	1.050	13



5.0



4.2

ORANGE/ ORANGE

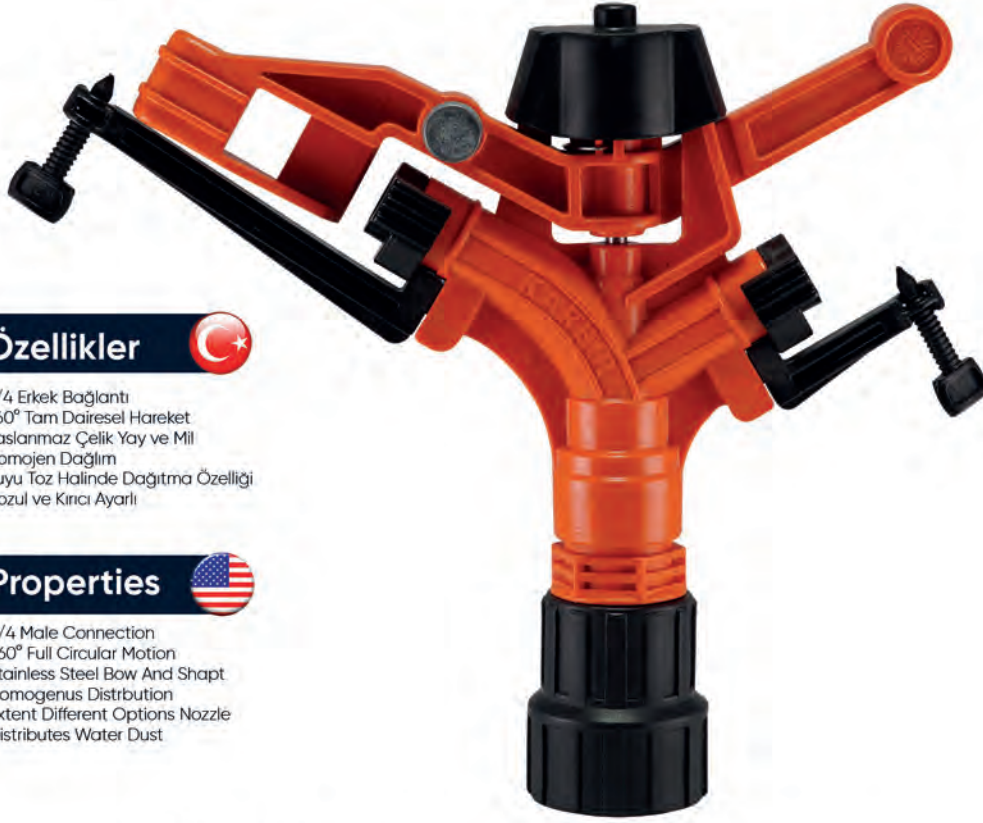

Özellikler



3/4 Erkek Bağlantı
360° Tam Dairesel Hareket
Paslanmaz Çelik Yay ve Mil
Homojen Dağılım
Suyu Toz Halinde Dağıtma Özelliği
Nozul ve Kırıcı Ayarlı

Properties



3/4 Male Connection
360° Full Circular Motion
Stainless Steel Bow And Shapt
Homogenous Distribution
Extent Different Options Nozzle
Distributes Water Dust

Ürün Kodu Product Code	Ölçü Size (mm)	Ambalaj Miktarı Packing Quantity	Koli Tipi Box Type	Fiyat Price ₺
ORG 5*4	3/4"	50	A-1	14.88
ORG 4*3	3/4"	50	A-1	14.88
ORG 3*2	3/4"	50	A-1	14.88

TEKNİK ÖZELLİKLER / TECHNICAL DATA

Nozul Nozzle	1,5 Bar		2 Bar		3 Bar	
	Debi Flowrare	Mesafe Distance	Debi Flowrare	Mesafe Distance	Debi Flowrare	Mesafe Distance
mm	m ³ /h	mt	m ³ /h	mt	m ³ /h	mt
5.0x 4.2	1.932	12	2.024	13	2.300	14
4.2 x 3.8	1.680	10	1.760	11	2.000	12
3.8 x 2.5	1.281	9	1.342	10	1.525	11



5.0-4.2-3.8 4.2-3.8-2.5

MODEL JAPON / MODEL JAPON



Özellikler



3/4 Erkek Bağlantı
360° Tam Dairesel Hareket
Paslanmaz Çelik Yay ve Mil
Homojen Dağılım
Suyu Toz Halinde Dağıtma Özelliği
Nozul ve kırıcı ayarlı

Properties



3/4 Male Connection
360° Full Circular Motion
Stainless Steel Bow And Shapt
Homogenous Distribution
Extent Different Options Nozzle
Distributes Water Dust

Ürün Kodu
Product Code

Ölçü
Size (mm)

Fiyat Price
₺

BLACK 5x2

3/4"

9.41

BLACK 4x2

3/4"

9.41

BLACK 3x2

3/4"

9.41

TEKNİK ÖZELLİKLER / TECHNICAL DATA

Nozul Nozzle	1,5 Bar		2 Bar		3 Bar	
	Debi Flowrare	Mesafe Distance	Debi Flowrare	Mesafe Distance	Debi Flowrare	Mesafe Distance
mm	m ³ /h	mt	m ³ /h	mt	m ³ /h	mt
5.0 x 3.2	2.024	12	2.116	13	2.208	14
4.2 x 3.8	1.760	10	1.840	11	1.920	12
3.8 x 2.5	1.386	9	1.449	10	1.512	11



5.0-4.2-3.8 4.2-3.8-2.5

SILVER / SILVER



Özellikler



1/2 Erkek Bağlantı
360° Tam Dairesel Hareket
Paslanmaz Çelik Yay ve Mil
Homojen Dağılım
Suyu Toz Halinde Dağıtma Özelliği
Nozul ve Kırıcı Ayarlı

Properties



1/2 Male Connection
360° Full Circular Motion
Stainless Steel Bow And Shapt
Homogenous Distribution
Extent Different Options Nozzle
Distributes Water Dust



Ürün Kodu
Product Code

Ölçü
Size (mm)

Fiyat Price
₺

SILVER 2*1 1/2" 6.32

SILVER 3*1 1/2" 6.32

SILVER 3*2 1/2" 6.32

TEKNİK ÖZELLİKLER / TECHNICAL DATA

Nozul Nozzle	1 Bar		1,5 Bar		2 Bar	
	Debi Flowrate	Mesafe Distance	Debi Flowrate	Mesafe Distance	Debi Flowrate	Mesafe Distance
mm	m ³ /h	mt	m ³ /h	mt	m ³ /h	mt
3.5 x 2.5	0.85	11	0.95	11	1.10	12
3.5 x 1.8	0.68	10	0.75	11	0.90	12
2.5 x 1.8	0.55	10	0.60	10	0.80	11



3.5-2.5



2.5-1.8

MINİ ATAK / MİNİ ATAK



Özellikler



1/2 Erkek Bağlantı
360° Tam Dairesel Hareket
Paslanmaz Çelik Yay ve Mil
Kendi Üzerinde 4 Farklı Debi Ayarı
Homojen Dağılım
Suyu Toz Halinde Dağıtma Özelliği
Tikinmeyen Yargılı Nozullar

Properties



1/2 Male Connection
360° Full Circular Motion
Stainless Steel Bow And Shapt
Homogenous Distribution
Extent Different Options Nozzle
Distributes Water Dust
Nozzle And Crusher Adjustable Sprinks Head



DEBİ AYARLI
NOZUL



Ürün Kodu
Product Code

Ölçü
Size (mm)

Ambalaj Miktarı
Packing Quantity

Koli Tipi
Box Type

Fiyat Price
Box Type

MINİ ATAK

1/2

150

A-1

9.25

TEKNİK ÖZELLİKLER / TECHNICAL DATA

Nozul Nozzle	1,5 Bar		1,5 Bar		2 Bar	
	Debi Flowrate	Mesafe Distance	Debi Flowrate	Mesafe Distance	Debi Flowrate	Mesafe Distance
mm	m ³ /h	mt	m ³ /h	mt	m ³ /h	mt
3.5 x 2.5	0.85	11	0.95	11	1.10	12
3.5 x 1.8	0.75	11	0.85	11	1.00	12
2.5 x 2.5	0.70	10	0.80	10	0.90	11
2.5 x 1.8	0.60	10	0.65	10	0.72	11



3.5-2.5



2.5-1.8

K - MİNİ ATAK / K - MİNİ ATAK



Özellikler



1/2 Erkek Bağlantı
360° Tam Dairesel Hareket
Paslanmaz Çelik Yay ve Mil
Kendi Üzerinde 4 Farklı Debi Ayarı
Homojen Dağılım
Suyu Toz Halinde Dağıtma Özelliği
Nozul ve Kırıcı Ayarlı Tıkinmayan Yargılı Nozullar

Properties



1/2 Male Connection
360° Full Circular Motion
Stainless Steel Bow And Shapt
Homogenous Distribution
Extent Different Options Nozzle
Distributes Water Dust
Nozzle And Crusher Adjustable Sprinks Head

AYARLANABİLİR
ROTAR KIRICI



Ürün Kodu
Product Code

Ölçü
Size (mm)

Ambalaj Miktarı
Packing Quantity

Koli Tipi
Box Type

Fiyat Price
Box Type

K-MİNİ ATAK

1/2

150

A-1

9.25

TEKNİK ÖZELLİKLER / TECHNICAL DATA

Nozul Nozzle	1,5 Bar		1,5 Bar		2 Bar	
	Debi Flowrare	Mesafe Distance	Debi Flowrare	Mesafe Distance	Debi Flowrare	Mesafe Distance
mm	m ³ /h	mt	m ³ /h	mt	m ³ /h	mt
3.5 x 2.5	0.85	11	0.95	11	1.10	12
3.5 x 1.8	0.75	11	0.85	11	1.00	12
2.5 x 2.5	0.70	10	0.80	10	0.90	11
2.5 x 1.8	0.60	10	0.65	10	0.72	11



3.5-2.5



2.5-1.8



Özellikler



- 30° Su Püskürtme
- 1/2 Erkek Bağlantı
- 360° Tam Dairesel Hareket
- Paslanmaz Çelik Yay ve Mil
- Homojen Dağılım
- Suyu Toz Halinde Dağıtma Özelliği
- Portatif Kırıcı
- Özel Hammadde

Properties



- 30° Water Spray
- 1/2 Male Connection
- 360° Full Circular Motion
- Stainless Steel Bow And Shapt
- Homogenous Distribution
- Extent Different Options Nozzle
- Portable Breaker
- Special Raw Material

PORTATİF
KIRICILI



Ürün Kodu Product Code	Ölçü Size (mm)	Ambalaj Miktarı Packing Quantity	Koli Tipi Box Type	Fiyat Price ₺
PARS 2*1	1/2"	150	A-1	9.10
PARS 3*1	1/2"	150	A-1	9.10
PARS 3*2	1/2"	150	A-1	9.10

TEKNİK ÖZELLİKLER / TECHNICAL DATA

Nozul Nozzle	1 Bar		1,5 Bar		2 Bar	
	Debi Flowrare m ³ /h	Mesafe Distance mt	Debi Flowrare m ³ /h	Mesafe Distance mt	Debi Flowrare m ³ /h	Mesafe Distance mt
3.5x 2.5	0.90	10	1.00	11	1.10	12
3.5 x 1.8	0.70	10	0.80	11	0.90	12
2.5 x 1.8	0.60	9	0.72	10	0.80	11



3.5-2.5



2.5-1.8

M - 16 / M-16



Özellikler



1/2 Erkek Bağlantı
360° Tam Dairesel Hareket
Paslanmaz Çelik Yay ve Mil
Homojen Dağılım
Suyu Toz Halinde Dağıtma Özelliği
Nozul ve Kırıcı Ayarlı

Properties



1/2 Male Connection
360° Full Circular Motion
Stainless Steel Bow And Shapt
Homogenous Distribution
Extent Different Options Nozzle
Distributes Water Dust

Ürün Kodu Product Code	Ölçü Size (mm)	Ambalaj Miktarı Packing Quantity	Koli Tipi Box Type	Fiyat Price ₺
M - 16 3*2	1/2"	225	A-1	8.85
M - 16 3*1	1/2"	225	A-1	8.85
M - 16 2*1	1/2"	225	A-1	8.85

TEKNİK ÖZELLİKLER / TECHNICAL DATA

Nozul Nozzle	1 Bar		1,5 Bar		2 Bar	
	Debi Flowrate m ³ /h	Mesafe Distance mt	Debi Flowrate m ³ /h	Mesafe Distance mt	Debi Flowrate m ³ /h	Mesafe Distance mt
3.5x 2.5	0.85	10	0.95	11	1.100	12
3.5 x 1.8	0.70	10	0.75	11	0.90	12
2.5 x 1.8	0.55	9	0.60	10	0.80	11



3.5



2.5



2.5



1.8

G - 30 MAXİ / G - 30 MAXİ

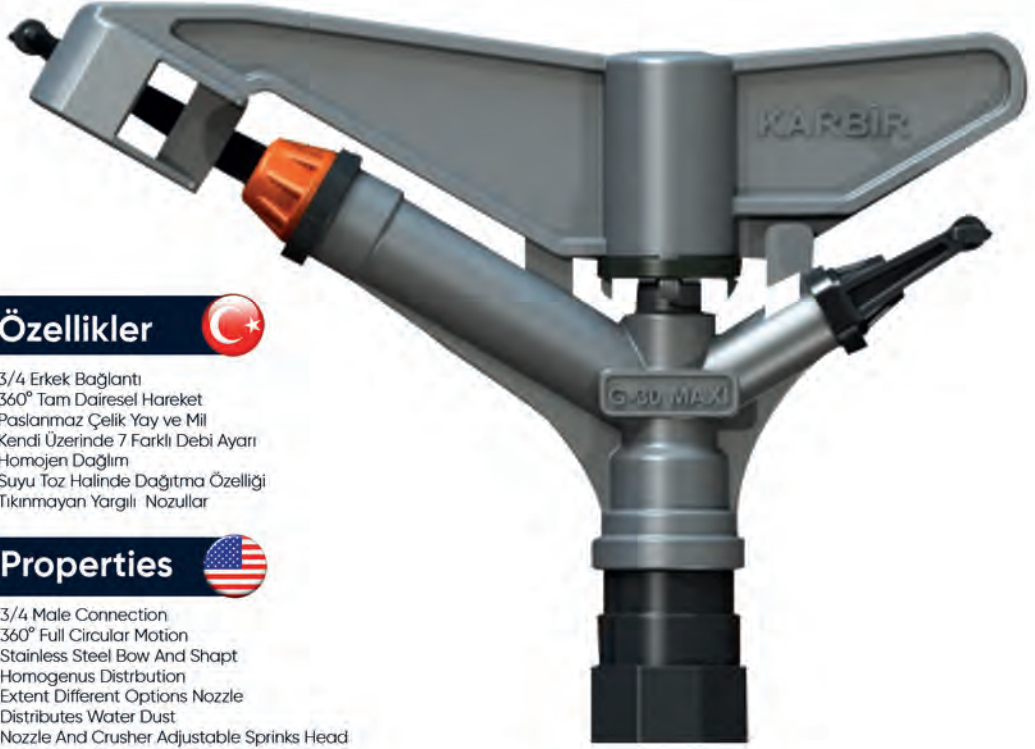

Özellikler



3/4 Erkek Bağlantı
360° Tam Dairesel Hareket
Paslanmaz Çelik Yay ve Mil
Kendi Üzerinde 7 Farklı Debi Ayarı
Homojen Dağılım
Suyu Toz Halinde Dağıtma Özelliği
Tikinmeyen Yargılı Nozullar

Properties



3/4 Male Connection
360° Full Circular Motion
Stainless Steel Bow And Shapt
Homogenous Distribution
Extent Different Options Nozzle
Distributes Water Dust
Nozzle And Crusher Adjustable Sprinks Head

Ürün Kodu Product Code	Ölçü Size (mm)	Ambalaj Miktarı Packing Quantity	Koli Tipi Box Type	Fiyat Price Box Type
G-30 MAXİ	3/4	50	A-1	15.46



5.0-4.5



4.2-3.8

HAYAT SU İLE BAŞLAR

**YAĞMURLAMA
EK PARÇALAR
SPRINKİLER
FITTINGS**

5 MT. MANDALLI BORU
LATCH CROSS

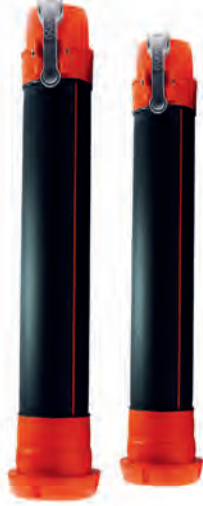

Ürün Kodu Product Code	Ölçü Size mm x mm	Fiyat Price
YB-50-5	Ø50XØ5	41.73
YB-63-5	Ø63XØ5	43.47
YB-75-5	Ø75XØ5	51.20
YB-90-5	Ø90XØ5	53.35
YB-110-5	Ø110XØ5	55.35
YB-125-5	Ø125XØ5	62.71
YB-140-5	Ø140XØ5	76.21
YB-160-5	Ø160XØ5	73.67

6 MT. MANDALLI BORU
LATCH TE



Ürün Kodu Product Code	Ölçü Size mm x mm	Fiyat Price
YB-50-6	Ø50XØ6	41.73
YB-63-6	Ø63XØ6	43.47
YB-75-6	Ø75XØ6	51.20
YB-90-6	Ø90XØ6	53.35
YB-110-6	Ø110XØ6	55.35
YB-125-6	Ø125XØ6	62.71
YB-140-6	Ø140XØ6	76.21
YB-160-6	Ø160XØ6	73.67

MANDALLI İSTAVROZ
LATCH CROSS

Ürün Kodu Product Code	Ölçü Size mm x mm	Fiyat Price	Ürün Kodu Product Code	Ölçü Size mm x mm	Fiyat Price
IS-75*50	Ø75XØ50	41.73	IS-125*75	Ø125XØ75	117.90
IS-75*63	Ø75XØ63	43.47	IS-125*90	Ø125XØ90	132.50
IS-75*75	Ø75XØ75	51.20	IS-125*110	125XØ110	140.40
IS-90*50	Ø90XØ50	53.35	IS-125*125	Ø125XØ125	165.20
IS-90*63	Ø90XØ63	55.35	IS-140*75	Ø140XØ75	153.30
IS-90*75	Ø90XØ75	62.71	IS-140*90	Ø140XØ90	168.70
IS-90*90	Ø90XØ90	76.21	IS-140*110	Ø140XØ110	177.80
IS-110*50	Ø110XØ50	73.67	IS-140*125	Ø140XØ125	202.10
IS-110*63	Ø110XØ63	74.57	IS-140*140	Ø140XØ140	234.40
IS-110*75	Ø110XØ75	81.29	IS-160*75	Ø160XØ75	183.30
IS-110*90	Ø110XØ90	94.35	IS-160*90	Ø160XØ90	198.10
IS-110*110	Ø110XØ110	103.40	IS-160*110	Ø160XØ110	206.50
IS-125*50	Ø125XØ50	108.30	IS-160*125	Ø160XØ125	230.80
IS-125*63	Ø125XØ63	110.00	IS-160*140	Ø160XØ140	263.10
			IS-160*160	Ø160XØ160	286.50

MANDALLI TE
LATCH TE

Ürün Kodu Product Code	Ölçü Size mm x mm	Fiyat Price	Ürün Kodu Product Code	Ölçü Size mm x mm	Fiyat Price
TE-75*50	Ø75XØ50	37,56	TE-125*75	Ø125XØ75	106,10
TE-75*63	Ø75XØ63	38,65	TE-125*90	Ø125XØ90	115,60
TE-75*75	Ø75XØ75	40,28	TE-125*110	Ø125XØ110	119,20
TE-90*50	Ø90XØ90	51,31	TE-125*125	Ø125XØ125	132,30
TE-90*63	Ø90XØ63	52,07	TE-140*75	Ø140XØ75	147,00
TE-90*75	Ø90XØ75	54,25	TE-140*90	Ø140XØ90	155,90
TE-90*90	Ø90XØ90	62,60	TE-140*110	Ø140XØ110	160,40
TE-110*50	Ø110XØ50	68,40	TE-140*125	Ø140XØ125	173,90
TE-110*63	Ø110XØ63	68,95	TE-140*140	Ø140XØ140	190,90
TE-110*75	Ø110XØ75	71,31	TE-160*75	Ø160XØ75	177,10
TE-110*90	Ø110XØ90	79,11	TE-160*90	Ø160XØ90	184,90
TE-110*110	Ø110XØ110	83,83	TE-160*110	Ø160XØ110	189,40
TE-125*50	Ø125XØ50	103,60	TE-160*125	Ø160XØ125	202,50
TE-125*63	Ø125XØ63	104,50	TE-160*140	Ø160XØ140	219,50
			TE-160*160	Ø160XØ160	231,70

ABOT
ABOT



Ürün Kodu Product Code	Ölçü Size mm	Fiyat Price
A-50	Ø50	12.50
A-63	Ø63	13.80
A-75	Ø75	19.75
A-90	Ø90	27.00

MANDALLI DİRSEK
LATCH ELBOW



Ürün Kodu Product Code	Ölçü Size mm	Fiyat Price
D-50	Ø50	21.05
D-63	Ø63	27.58
D-75	Ø75	29.03
D-90	Ø90	39.74
D-110	Ø110	53.71
D-125	Ø125	93.04
D-140	Ø140	151.00
D-160	Ø160	194.10

MANDALLI REDÜKSİYON
LATCH REDUCTION



Ürün Kodu Product Code	Ölçü Size mm	Fiyat Price	Ürün Kodu Product Code	Ölçü Size mm	Fiyat Price
R-90X75	Ø90XØ75	29,76	R-140X90	Ø140XØ90	90,18
R-110X75	Ø110XØ75	41,73	R-140X110	Ø140XØ110	95,44
R-110X90	Ø110XØ90	49,90	R-140X125	Ø140XØ125	108,50
R-125X75	Ø125XØ75	60,60	R-160X110	Ø160XØ110	117,40
R-125X90	Ø125XØ90	69,13	R-160X125	Ø160XØ125	131,40
R-125X110	Ø125XØ110	75,12	R-160X140	Ø160XØ140	149,30

TERS REDÜKSİYON
ADVERSE REDUCTION



Ürün Kodu Product Code	Ölçü Size mm	Fiyat Price	Ürün Kodu Product Code	Ölçü Size mm	Fiyat Price
TR 75X90	Ø75XØ90	34,47	TR 110X125	Ø110XØ125	68,95
TR 75X110	Ø75XØ110	42,46	TR 110X140	Ø110XØ140	93,15
TR 75X125	Ø75XØ125	54,98	TR 110X160	Ø110XØ160	114,50
TR 90X110	Ø90XØ110	46,10	TR 125X140	Ø125XØ140	115,70
TR 90X125	Ø90XØ125	59,88	TR 125X160	Ø125XØ160	132,40
TR 90X140	Ø90XØ140	83,28	TR 140X160	Ø140XØ160	143,20

MANDALLI KÖRTAPA (ERKEK)
LATCH BLIND PLUG (MALE)



Ürün Kodu Product Code	Ölçü Size mm	Fiyat Price	Ürün Kodu Product Code	Ölçü Size mm	Fiyat Price
KE-50	Ø50	7,90	KE-110	Ø110	23,22
KE-63	Ø63	8,45	KE-125	Ø125	44,45
KE-75	Ø75	11,72	KE-140	Ø140	58,00
KE-90	Ø90	14,52	KE-160	Ø160	71,31

MANDALLI KÖRTAPA (DIŞİ)
LATCH BLIND PLUG (FEMALE)



Ürün Kodu Product Code	Ölçü Size mm	Fiyat Price	Ürün Kodu Product Code	Ölçü Size mm	Fiyat Price
KD-50	Ø50	3.30	KD-110	Ø110	17.10
KD-63	Ø63	3.95	KD-125	Ø125	29.94
KD-75	Ø75	6.90	KD-140	Ø140	45.50
KD-90	Ø90	13.25	KD-160	Ø160	56.25

MANDALLI BAŞLIK (ERKEK)
LATCH HEAD (MALE)



Ürün Kodu Product Code	Ölçü Size mm	Fiyat Price	Ürün Kodu Product Code	Ölçü Size mm	Fiyat Price
BE-50	Ø50	7.70	BE-110	Ø110	20.68
BE-63	Ø63	8.08	BE-125	Ø125	38.65
BE-75	Ø75	10.52	BE-140	Ø140	51.17
BE-90	Ø90	13.32	BE-160	Ø160	67.86

MANDALLI BAŞLIK (DIŞİ)
LATCH HEAD (FEMALE)



Ürün Kodu Product Code	Ölçü Size mm	Fiyat Price	Ürün Kodu Product Code	Ölçü Size mm	Fiyat Price
BD-50	Ø50	3.20	BD-110	Ø110	15.42
BD-63	Ø63	3.75	BD-125	Ø125	27.22
BD-75	Ø75	4.72	BD-140	Ø140	43.55
BD-90	Ø90	11.98	BD-160	Ø160	52.07

MANDALLI CONTA
LATCH GASKET



Ürün Kodu Product Code	Ölçü Size mm	Fiyat Price
C-50	Ø50	0.87
C-63	Ø63	0.94
C-75	Ø75	1.13
C-90	Ø90	1.70
C-110	Ø110	2.36
C-125	Ø125	4.54
C-140	Ø140	6.50
C-160	Ø160	7.80

ABOT ADAPTÖRÜ
ABOT ADAPTOR



Ürün Kodu Product Code	Ölçü Size mm	Fiyat Price
AA	Ø40X32	1.09

MANŞON
MUFF



Ürün Kodu Product Code	Ölçü Size mm	Fiyat Price
M-32X20	Ø32X20	0,78
M-32X25	Ø32X25	0,86
M-32X32	Ø32X32	1,20

NOZUL
NOZZLE



Ürün Kodu Product Code	Ölçü Size Debi	Fiyat Price
NZL 1/2	1/2 SPRİNK	0,56
NZL 3/4	3/4 SPRİNK	0,65

MANDAL TAKIMI (PİM & YAY)
LATCH SET (GIB & BOW)



Ürün Kodu Product Code	Ölçü Size mm	Fiyat Price
MNDL-50	Ø50	3.63
MNDL-63	Ø63	3.63
MNDL-75	Ø75	4.00
MNDL-90	Ø90	4.71
MNDL-110	Ø110	5.26
MNDL-125	Ø125	8.90



**UZATMA BORUSU
MINİ SPRINK
SİSTEMLERİ**
EXTENSION PIPE
MINI SPRINKLER
SYSTEM

32MM. BEYAZ UZATMA BORUSU
WHITE EXTENSION PIPE



Ürün Kodu Product Code	Ölçü Size mm	Paket Miktarı Package Quantity Adet Piece	Fiyat Price
U-B 25	Ø32X25	250	2.13
U-B 33	Ø32X33	200	2.81
U-B 40	Ø32X40	100	3.40
U-B 50	Ø32X50	100	4.26
U-B 60	Ø32X60	100	5.11
U-B 75	Ø32X75	100	6.39
U-B 100	Ø32X100	100	8.52
U-B 120	Ø32X120	100	10.73
U-B 150	Ø32X150	75	13.42
U-B 200	Ø32X200	50	17.89

40MM. BEYAZ UZATMA BORUSU
WHITE EXTENSION PIPE



Ürün Kodu Product Code	Ölçü Size mm	Paket Miktarı Package Quantity Adet Piece	Fiyat Price
U-B 40 - 25	Ø40X25	250	2.13
U-B 40 - 33	Ø40X33	200	2.81
U-B 40 - 40	Ø40X40	100	3.40
U-B 40 - 50	Ø40X50	100	4.26
U-B 40 - 60	Ø40X60	100	5.11
U-B 40 - 75	Ø40X75	100	6.39
U-B 40 - 100	Ø40X100	100	8.52

KÜRESEL VANA
BALL VALVE



Ürün Kodu Product Code	Ölçü Size mm	Paket Miktarı Package Quantity Adet Piece	Fiyat Price
V-32	Ø32	100	3.25

MINİ İSTAVROZ
MINI CROSS



Ürün Kodu Product Code	Ölçü Size mm	Paket Miktarı Package Quantity Adet Piece	Fiyat Price
A-32	Ø32 x 20 x 32	200	2.06

MINİ SPRINK ADAPRÖTÜ
MINI SPRINKLER CUPLING



Ürün Kodu Product Code	Ölçü Size mm	Paket Miktarı Package Quantity Adet Piece	Fiyat Price
M-32	20 x 20	400	1.15

SOMUNLU TE
MINI TE



Ürün Kodu Product Code	Ölçü Size mm	Paket Miktarı Package Quantity Adet Piece	Fiyat Price
T-20	20 x 20 x 20	500	2.06

PASLANMAZ DEMİR ÇUBUK
STAINLESS IRON ROT



Ürün Kodu Product Code	Ölçü Size mm	Fiyat Price
P 80	80	FİYAT SORUNUZ
P 100	100	FİYAT SORUNUZ
P 120	120	FİYAT SORUNUZ





HAT VANALARI
LINE VALVES

RAPİD VANA
RAPID VALVE

Ürün Kodu Product Code	Ölçü Size mm	Ambalaj Miktarı	Koli Tipi	Fiyat Price
RAPID 50	Ø50	20	A-2	* ÜRETİM AŞAMASINDA
RAPID 63	Ø63	20	A-2	* ÜRETİM AŞAMASINDA
RAPID 75	Ø75	20	A-2	66,04
RAPID 90	Ø90	20	A-2	* ÜRETİM AŞAMASINDA
RAPID 110	Ø110	20	A-2	* ÜRETİM AŞAMASINDA



MANDALLI HAT VANASI (KÜRESEL)
LATCH VALVE (BALL)

Ürün Kodu Product Code	Ölçü Size mm	Fiyat Price
VKÜ-M 50	Ø50	47, 20
VKÜ-M 63	Ø63	52, 60
VKÜ-M 75	Ø75	81, 65
VKÜ-M 90	Ø90	120, 50
VKÜ-M 110	Ø110	161, 30

MANDALLI HAT VANASI (KELEBEK)
LATCH VALVE (BUTTERFLY)

Ürün Kodu Product Code	Ölçü Size mm	Fiyat Price
VKE-M 125	Ø125	







DAMLAMA EK
PARÇALARI
DRIP FITTINGS

MİNİ VANA YÜZÜKLÜ
MINI VALVE WITH RING



Ürün Kodu
Product Code

Ölçü
Size
mm

Fiyat
Price

VY-17*17

Ø17XØ17

1.88

VY-22*22

Ø22XØ22

2.20

VY-25*25

Ø25XØ25

2.36

MİNİ VANA YÜZÜKLÜ CONTA ÇIKIŞLI
MINI VALVE WITH GASKET OUTLED AND RING



Ürün Kodu
Product Code

Ölçü
Size
mm

Fiyat
Price

VCY-16*17

Ø16XØ17

1.80

VCY-16*22

Ø16XØ22

1.97

VCY-20*22

Ø20XØ22

2.06

VCY-20*25

Ø20XØ25

2.14

MİNİ VANA YÜZÜKLÜ DIŞ DIŞLI
MINI VALVE WITH EXTERNAL GEAR AND RING



Ürün Kodu
Product Code

Ölçü
Size
mm

Fiyat
Price

VEY-1/2*17

1/2XØ17

1.84

VEY-1/2*22

1/2XØ22

2.06

VEY-1/2*25

1/2XØ25

2.16

MİNİ VANA YÜZÜKLÜ KURTAĞIZI
MINI VALVE WITH DOVETAIL AND RING



Ürün Kodu
Product Code

Ölçü
Size
mm

Fiyat
Price

VKY-16*17

Ø16XØ17

1.80

VKY-20*22

Ø20XØ22

2.06

VKY-20*25

Ø20XØ25

2.10

MİNİ VANA KURTAĞIZI
MINI VALVE WITH DOVETAIL

Ürün Kodu Product Code	Ölçü Size mm	Fiyat Price
VK-16*16	Ø16XØ16	1.65
VK-20*16	Ø20XØ16	1.69
VK-20*20	Ø20XØ20	1.72

MİNİ VANA KURTAĞIZI CONTA ÇIKIŞLI
MINI VALVE WITH GASKET OUTLET AND DOVETAIL

Ürün Kodu Product Code	Ölçü Size mm	Fiyat Price
VCK-16*16	Ø16XØ16	1.66
VCK-16*20	Ø16XØ20	1.75
VCK-20*20	Ø20XØ20	1.78

MİNİ VANA KURTAĞIZI DIŞ DIŞLI
MINI VALVE WITH EXTERNAL GEAR AND DOVETAIL

Ürün Kodu Product Code	Ölçü Size mm	Fiyat Price
VEK-1/2*16	1/2XØ16	1.74
VEK-1/2*20	1/2XØ20	1.77

DİRSEK YÜZÜKLÜ DIŞ DIŞLI
DRIP IRRIGATION ELBOW WITH ECTERNAL GEAR AND RING

Ürün Kodu Product Code	Ölçü Size mm	Fiyat Price
DEY-1/2*17	Ø1/2"X17	0.85
DEY-1/2*22	Ø1/2"X22	1.05
DEY-1/2*25	Ø1/2"X25	1.36

ÜÇ YOLLU MİNİ VANA CONTA ÇIKIŞLI

THREE WAY MINI VALVE WITH GASKET OUTLET AND RING



Ürün Kodu Product Code	Ölçü Size mm	Fiyat Price
3VCY-17*16*17	Ø17XØ16XØ17	2,65
3VCY-17*20*17	Ø17XØ20XØ17	2,72
3VCY-22*20*22	Ø22XØ20XØ22	3,10
3VCY-25*20*25	Ø25XØ20XØ25	3,60

ÜÇ YOLLU MİNİ VANA DIŞ DIŞLI

THREE WAY MINI VALVE WITH EXTERNAL GEAR AND RING



Ürün Kodu Product Code	Ölçü Size mm	Fiyat Price
3VEY-17*1/2*17	Ø17X1/2"XØ17	2,72
3VEY-22*1/2*22	Ø22X1/2"XØ22	3,10
3VEY-25*1/2*25	Ø25X1/2"XØ25	3,60

VANALI DİRSEK DIŞTAN DIŞLI

VALVE ELBOW WITH EXTERNAL GEAR AND RING



Ürün Kodu Product Code	Ölçü Size mm	Fiyat Price
3DEY-17*1/2	Ø17X1/2"	2,62
3DEY-22*1/2	Ø22X1/2"	3,00
3DEY-25*1/2	Ø25X1/2"	3,50

VANALI DİRSEK CONTA ÇIKIŞLI

VALVE ELBOW WITH GASKET OUTLET AND RING



Ürün Kodu Product Code	Ölçü Size mm	Fiyat Price
3DCY-17*20	Ø17XØ20	2,62
3DCY-22*20	Ø22XØ20	3,00
3DCY-25*20	Ø25XØ20	3,50

EKLEME NİPELİ YÜZÜKLÜ
ADDING NIPPLE WITH RING

Ürün Kodu Product Code	Ölçü Size mm	Fiyat Price
NY-17*17	Ø17XØ17	0,45
NY-22*22	Ø22XØ22	0,64
NY-25*25	Ø25XØ25	0,85

ÇIKIŞ NİPELİ YÜZÜKLÜ

OUTLET NIPPLE WITH GASKET OUTLET AND RING



Ürün Kodu Product Code	Ölçü Size mm	Fiyat Price
NCY-16*17	Ø16XØ17	0,32
NCY-16*22	Ø16XØ22	0,40
NCY-20*22	Ø20XØ22	0,48
NCY-20*25	Ø20XØ25	0,59

TE YÜZÜKLÜ CONTA ÇIKIŞ

TE WITH GASKET OUTLET AND RING



Ürün Kodu Product Code	Ölçü Size mm	Fiyat Price
TCY-17*16*17	Ø17XØ16XØ17	1,25
TCY-17*20*17	Ø17XØ20XØ17	1,36
TCY-22*20*22	Ø22XØ20XØ22	1,50
TCY-25*20*25	Ø25XØ20XØ25	1,82

TE YÜZÜKLÜ DIŞ DIŞLI

TE WITH EXTERNAL GEAR AND RING



Ürün Kodu Product Code	Ölçü Size mm	Fiyat Price
TEY-17* ½*17	Ø17 X ½" X Ø17	1.32
TEY-22* ½*22	Ø22 X ½" X Ø22	1.60
TEY-25* ½*25	Ø25 X ½" X Ø25	1.95

EKLEME NİPELİ KURTAĞZI

ADDING NIPPLE WITH DOVETAILED



Ürün Kodu Product Code	Ölçü Size mm	Fiyat Price
NK-16*16	Ø16 x Ø16	0.26
NK-16*20	Ø16 x Ø20	0.33
NK-20*20	Ø20 x Ø20	0.39

ÇIKIŞ NİPELİ KURTAĞZI

OUTLET NIPPLE WITH GASKET OUTLET AND DOVETAILED



Ürün Kodu Product Code	Ölçü Size mm	Fiyat Price
NCK-16*16	Ø16 x Ø16	0.28
NCK-16*20	Ø16 x Ø20	0.34
NCK-20*20	Ø20 x Ø20	0.40

DİRSEK KURTAĞZI

DRIP IRRIGATION ELBOW WITH DOVETAILED



Ürün Kodu Product Code	Ölçü Size mm	Fiyat Price
DK-16*16	Ø16X16	0.30
DK-20*20	Ø20X20	0.39

TE KURTAĞZI

TE WITH DOVETAILED



Ürün Kodu Product Code	Ölçü Size mm	Fiyat Price
TK-16*16*16	Ø16XØ16XØ16	0.45
TRK-16*20*16	Ø16XØ20XØ16	0.50
TRK-20*16*20	Ø20XØ16XØ20	0.52
TK-20*20*20	Ø20XØ20XØ20	0.56

DAMLATICI

ADJUSTABLE FLOW DRIPPER



Ürün Kodu Product Code	Ölçü Size mm	Fiyat Price
DK	(0.70 h/lt)	0.25
DB	(0.140 h/lt)	0.31

KURTAĞZI KÖRTAPA

DRIP IRRIGATION STOPPER



Ürün Kodu Product Code	Ölçü Size mm	Fiyat Price
KK-16	Ø16	0.27
KK-20	Ø20	0.35

EKLEME NİPELİ KURTAĞZI
ADDING NIPPLE WITH DOVETAILED

Ürün Kodu Product Code	Ölçü Size mm	Paket Miktarı (Adet)
NK-S-16*16	Ø10	2000
NK-S-20*20	Ø20	1500

ÇIKIŞ NİPELİ KURTAĞZI

OUTLET NIPPLE WITH GASKET OUTLET AND DOVETAILED



Ürün Kodu Product Code	Ölçü Size mm	Paket Miktarı (Adet)
NCK-S-16*16	Ø16X16	2000
NCK-S-20*20	Ø20X20	1500

DİRSEK KURTAĞZI

DRIP IRRIGATION ELBOW WITH DOVETAILED



Ürün Kodu Product Code	Ölçü Size mm	Paket Miktarı (Adet)
DK-S-16*16	Ø16X16	2000
DK-S-20*20	Ø20X20	1500

TE KURTAĞZI

TE WITH DOVETAILED



Ürün Kodu Product Code	Ölçü Size mm	Fiyat Price
TK-S-16*16*16	Ø16XØ16XØ16	0.45
TRK-S-16*20*16	Ø16XØ20XØ16	0.50
TRK-S-20*16*20	Ø20XØ16XØ20	0.52
TK-S-20*20*20	Ø20XØ20XØ20	0.56

KURTAĞZI KÖRTAPA

DRIP IRRIGATION STOPPER



Ürün Kodu Product Code	Ölçü Size mm	Paket Miktarı (Adet)
KK-S-16	Ø16	3000
KK-S-20	Ø20	2000

NATURAL KANALLI CONTA

DRIP IRRIGATION OUTLET GASKET GROOVED



Ürün Kodu Product Code	Ölçü Size mm	Fiyat Price
CK-16	Ø16	0,25
CK-20	Ø20	0,27

DRIP DELME APARATI

DRIPPER PERFORATION TOOL



Ürün Kodu Product Code	Ölçü Size mm	Paket Miktarı (Adet)
DDA-3	Ø3	7,25

ANA BORU DELME APARATI (MANUEL)

MAIN PIPE PERFORATION TOOL (MANUAL)



Ürün Kodu Product Code	Ölçü Size mm	Fiyat Price
DA-16	Ø16	8,70
DA-20	Ø20	9,43

ANA BORU DELME APARATI (MATKAP İÇİN)

MAIN PIPE PERFORATION TOOL (FOR DRILL)



Ürün Kodu Product Code	Ölçü Size mm	Fiyat Price
DAM-16	Ø16	6,90
DAM-20	Ø20	7,25

BASINÇ AYARLI DAMLATICI
PC DRIPPERÜrün Kodu
Product CodeÖlçü
Size
mmFiyat
Price

PCD-2

Ø2 mm

BASINÇ AYARLI DAMLATICI
PC DRIPPERÜrün Kodu
Product CodeÖlçü
Size
mmFiyat
Price

PCD-4

Ø4 mm

BASINÇ AYARLI DAMLATICI
PC DRIPPERÜrün Kodu
Product CodeÖlçü
Size
mmFiyat
Price

PCD-8

Ø8 mm

BASINÇ AYARLI DAMLATICI
PC DRIPPERÜrün Kodu
Product CodeÖlçü
Size
mmFiyat
Price

PCD-16

Ø16 mm

YUVARLAK DAMLAMA BORUSU (DRİPSİZ)
ROUND DRIP PIPE (NO DRIP)



Ürün Kodu Product Code	Ölçü Size mm x cm	Et Kalınlığı Wall Thickness mm	Ambalaj/Rulo Packing/Roll mt	Fiyat Price
DB-16-1	Ø16	1.0	400	249.70
DB-16-1.2	Ø20	1.2	300	284.50

DAMLAMA SULAMA BORUSU (400 mt / rulo)
DRIP IRRIGATION PIPE (400 metres / roll)



Ürün Kodu Product Code	Ölçü Size mm x cm	Et Kalınlığı Wall Thickness mm	Ambalaj/Rulo Packing/Roll mt	Damlatıcı aralığı Dripper Spaces cm	Fiyat Price
DB-16-4-09-20	Ø16	0.9	4	20	278.70
DB-16-4-09-25	Ø16	0.9	4	25	284.50
DB-16-4-09-33	Ø16	0.9	4	33	270.00
DB-16-4-09-40	Ø16	0.9	4	40	264.20
DB-16-4-09-50	Ø16	0.9	4	50	258.40

YASSI DAMLAMA BORUSU

17 (mm) 6 mil (0,15 mm)						
Kodu 1 Lt/h	Kodu 1,6 Lt/h	Kodu 2,2 Lt/h	Kodu 3,5 Lt/h	Damlaticı Aralığı (cm)	Ambalaj Metraji	TL/Mt
170620-10	170620-16	170620-22	170620-35	20	2500	0,123
170625-10	170625-16	170625-22	170625-35	25	2500	0,118
170630-10	170630-16	170630-22	170630-35	33	2500	0,115

17 (mm) 7 mil (0,17 mm)						
Kodu 1 Lt/h	Kodu 1,6 Lt/h	Kodu 2,2 Lt/h	Kodu 3,5 Lt/h	Damlaticı Aralığı (cm)	Ambalaj Metraji	TL/Mt
170720-10	170720-16	170720-22	170720-35	20	2400	0,132
170725-10	170725-16	170725-22	170725-35	25	2400	0,129
170730-10	170730-16	170730-22	170730-35	33	2400	0,126

17 (mm) 8 mil (0,20 mm)						
Kodu 1 Lt/h	Kodu 1,6 Lt/h	Kodu 2,2 Lt/h	Kodu 3,5 Lt/h	Damlaticı Aralığı (cm)	Ambalaj Metraji	TL/Mt
170820-10	170820-16	170820-22	170820-35	20	2300	0,142
170825-10	170825-16	170825-22	170825-35	25	2300	0,139
170830-10	170830-16	170830-22	170830-35	33	2300	0,126

17 (mm) 10 mil (0,25 mm)						
Kodu 1 Lt/h	Kodu 1,6 Lt/h	Kodu 2,2 Lt/h	Kodu 3,5 Lt/h	Damlaticı Aralığı (cm)	Ambalaj Metraji	TL/Mt
171020-10	171020-16	171020-22	171020-35	20	2000	
171025-10	171025-16	171025-22	171025-35	25	2000	
171030-10	171030-16	171030-22	171030-35	33	2000	

17 (mm) 12 mil (0,30 mm)						
Kodu 1 Lt/h	Kodu 1,6 Lt/h	Kodu 2,2 Lt/h	Kodu 3,5 Lt/h	Damlaticı Aralığı (cm)	Ambalaj Metraji	TL/Mt
171220-10	171220-16	171220-22	171220-35	20	1700	
171225-10	171225-16	171225-22	171225-35	25	1700	
171230-10	171230-16	171230-22	171230-35	33	1700	

22 (mm) 8 mil (0,20 mm)						
Kodu 1 Lt/h	Kodu 1,6 Lt/h	Kodu 2,2 Lt/h	Kodu 3,5 Lt/h	Damlaticı Aralığı (cm)	Ambalaj Metraji	TL/Mt
220820-10	220820-16	220820-22	220820-35	20	1800	0,188
220825-10	220825-16	220825-22	220825-35	25	1800	0,181
220830-10	220830-16	220830-22	220830-35	33	1800	0,174

22 (mm) 10 mil (0,25 mm)						
Kodu 1 Lt/h	Kodu 1,6 Lt/h	Kodu 2,2 Lt/h	Kodu 3,5 Lt/h	Damlaticı Aralığı (cm)	Ambalaj Metraji	TL/Mt
221020-10	221020-16	221020-22	221020-35	20	1500	0,218
221025-10	221025-16	221025-22	221025-35	25	1500	0,212
221030-10	221030-16	221030-22	221030-35	33	1500	0,206

22 (mm) 12 mil (0,30 mm)						
Kodu 1 Lt/h	Kodu 1,6 Lt/h	Kodu 2,2 Lt/h	Kodu 3,5 Lt/h	Damlaticı Aralığı (cm)	Ambalaj Metraji	TL/Mt
221220-10	221220-16	221220-22	221220-35	20	1200	0,251
221225-10	221225-16	221225-22	221225-35	25	1200	0,243
221230-10	221230-16	221230-22	221230-35	33	1200	0,236

22 (mm) 12 mil (0,30 mm)						
Kodu 1 Lt/h	Kodu 1,6 Lt/h	Kodu 2,2 Lt/h	Kodu 3,5 Lt/h	Damlaticı Aralığı (cm)	Ambalaj Metraji	TL/Mt
251020-10	251020-16	251020-22	251020-35	20	1300	
251025-10	251025-16	251025-22	251025-35	25	1300	
251030-10	251030-16	251030-22	251030-35	33	1300	

22 (mm) 12 mil (0,30 mm)						
Kodu 1 Lt/h	Kodu 1,6 Lt/h	Kodu 2,2 Lt/h	Kodu 3,5 Lt/h	Damlaticı Aralığı (cm)	Ambalaj Metraji	TL/Mt
251220-10	251220-16	251220-22	251220-35	20	1000	0,292
251225-10	251225-16	251225-22	251225-35	25	1000	0,28
251230-10	251230-16	251230-22	251230-35	33	1000	0,28







FİLTRASYON
FİLTRASYON

ŞASELİ HİDROSİKLOKON DOUBLE SİSTEM
CHIRAL HYDROCYCLONE DOUBLE SYSTEM



Ürün Kodu
Product Code

Ölçü
Size tinc

ŞHS - 5 x 2 x 4

5 x 2 x 4"

ŞHS - 5 x 3 x 4

5 x 3 x 4"

ŞHS - 6 x 4 x 4

6 x 4 x 4"

ŞASELİ SEPARATÖR DOUBLE SİSTEM
CHIRAL SEPARATOR DOUBLE SYSTEM



Ürün Kodu
Product Code

Ölçü
Size tinc

ŞSS - 5 x 2 x 4

5 x 2 x 4"

ŞSS - 5 x 3 x 4

5 x 3 x 4"

ŞSS - 6 x 4 x 4

6 x 4 x 4"

PLASTİK DİSK FİLTRELİ GRAVEL SİSTEM



Ürün Kodu
Product Code

Ölçü
Size tinc

PDG-2x3x4

2x3"x4"

PDG-3x3x5

3x3"x5"

PDG-4x3x6

4x3"x6"

PDG-3x4x6

3x4"x6"

PDG-4x4x6

4x4"x6"

PDG-5x4x6

5x4"x6"

PDG-3x4x6

3x4"x6"

PDG-4x4x6

4x4"x6"

YATAY GÜBRELEME TANKI
 HORIZONTAL FERTILIZER TANK

Ürün Kodu Product Code	Ölçü Size lt
Y GT -100	100
Y GT -200	200
Y GT -300	300
Y GT -400	400

DİKEY GÜBRELEME TANKI
 HORIZONTAL FERTILIZER TANK

Ürün Kodu Product Code	Ölçü Size lt
D GT - 60	60
D GT- 100	100

GRAVEL TANK

Ürün Kodu Product Code	Ölçü Size tinc
GGT-2x18	2"x18"
GGT-2x24	2½"x24"
GGT-3x24	3"x24"
GGT-4x24	4"x24"
GGT-3x31	3"x31"
GGT-3x36	3"x36"
GGT-4x26	4"x26"
GGT-4x48	4"x48"

AYAKLI DİSK FİLTRE
 POD DISC FILTER

Ürün Kodu Product Code	Ölçü Size tinc
A DF-2	2"
A DF-2½	2½"
A DF-3	3"
A DF-3(GENİŞ)	3"
A DF-4	4"
A DF-4 (GENİŞ)	4"



METALEK
PARÇALARI
METAL
FITTINGS

**MOTOPOMP METAL DİŞLİ PLASTİK (ERKEK)**

MOTOPOMP METAL THERADED PLASTIC (MALE)

Ürün Kodu Product Code	Ölçü Size mm	Ürün Kodu Product Code	Ölçü Size mm
PE MP - 63	Ø63	PE MP - 125	Ø125
PE MP - 75	Ø75	PE MP - 140	Ø 140
PE MP - 90	Ø90	PE MP - 160	Ø160
PE MP - 110	Ø110		

**MOTOPOMP METAL DİŞLİ PLASTİK (DİŞİ)**

MOTOPOMP METAL THERADED PLASTIC (FEMALE)

Ürün Kodu Product Code	Ölçü Size mm	Ürün Kodu Product Code	Ölçü Size mm
PD MP - 63	Ø63	PD MP - 125	Ø125
PD MP - 75	Ø75	PD MP - 140	Ø 140
PD MP - 90	Ø90	PD MP - 160	Ø160
PD MP - 110	Ø110		

**DEMİR MOTOPOMP (ERKEK)**

IRON MOTOPOMP (MALE)

Ürün Kodu Product Code	Ölçü Size mm	Ürün Kodu Product Code	Ölçü Size mm
ED MP - 63	Ø63	ED MP - 125	Ø125
ED MP - 75	Ø75	ED MP - 140	Ø 140
ED MP - 90	Ø90	ED MP - 160	Ø160
ED MP - 110	Ø110		

**DEMİR MOTOPOMP (DİŞİ)**

IRON MOTOPOMP (FEMALE)

Ürün Kodu Product Code	Ölçü Size mm	Ürün Kodu Product Code	Ölçü Size mm
DD MP - 63	Ø63	DD MP - 125	Ø125
DD MP - 75	Ø75	DD MP - 140	Ø 140
DD MP - 90	Ø90	DD MP - 160	Ø160
DD MP - 110	Ø110		



EXPORT



Mahmut KAYA

+90 538 637 04 54
export@karbir.com.tr

AFGHANISTAN	CROATIA	KAZAKHSTAN	NIGERIA	SWEDEN
ALBANIA	CUBA	KENYA	OMAN	SWITZERLAND
ALGERIA	CZECHIA	KOREA,NORTH	PAKISTAN	SYRIA
ARGENTINA	CYPRUS	KOREA,SOUTH	PALESTINIAN T.	TAIWAN
ARMENIA	EGYPT	KOSOVO	PARAGUAY	TAJIKISTAN
ARUBA	ETHIOPIA	KUWAIT	PERU	TANZANIA
AUSTRALIA	FRANCE	KYRGYZSTAN	POLAND	TUNISA
AUSTRIA	GEORGIA	LEBANON	PORTUGAL	TURMENISTAN
AZERBAIJAN	GERMANY	LIBYA	QATAR	UKRAINE
BAHRAIN	GREECE	MACEDONIA	ROMANIA	U. ARAB EMIRATES
BELARUS	HUNGARY	MADAGASKAR	RUSSIA	UNITED KINGDOM
BELGIUM	INDIA	MALI	SAUDI ARABIA	URUGUAY
BOSNIA H.	IRAN	MALTA	SERBIA	UZBEKISTAN
BULGARIA	IRAQ	MOLDOVA	SOUTH AFRICA	YEMEN
CHILE	ITALY	MOROCCO	SOUTH SUDAN	
COTE D'IVOIRE	JORDAN	NETHERLANDS	SUDAN	



BÖLGE SATIŞ TEMSİLCİLERİ

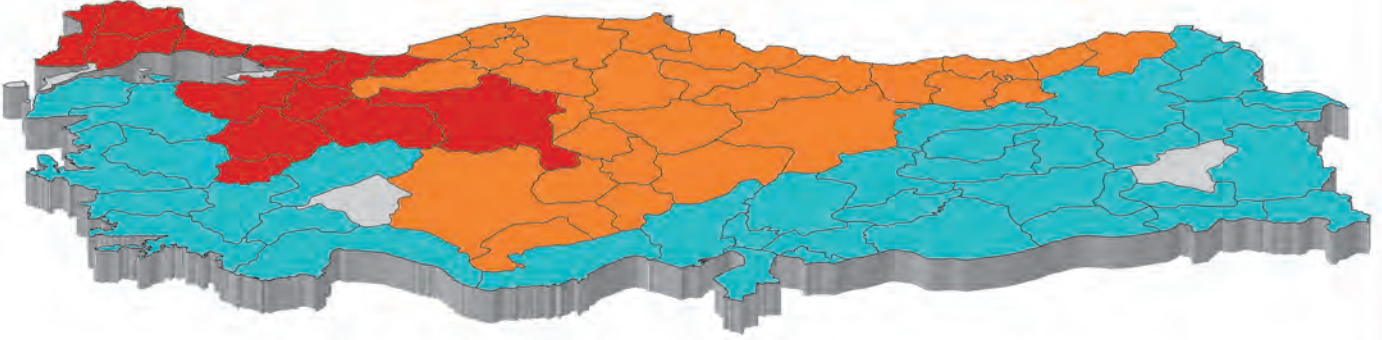

Emre UÇGUN

+90 533 453 41 55
eucgun@karbir.com.tr



Murat SAYIM

+90 533 059 35 32
msayim@karbir.com.tr



Adnan AKDAĞ

+90 533 401 51 41
aakdag@karbir.com.tr

ZONGULDAK YOZGAT
BARTIN GÜMÜŞHANE
KASTAMONU BAYBURT
RİZE KAYSERİ
ARTVİN NİĞDE
ORDU ÇUMRA
GİRESUN KIRŞEHİR
TRABZON NEVŞEHİR
TOKAT KARAMAN
SİVAS BOZKIR
ÇANKIRI GÜNEYSINIR
ÇORUM KARAPINAR
AMASYA EREĞLİ
KIRIKKALE SİNOP
SAMSUN

ÇANAKKALE
BALIKESİR
MANİSA
İZMİR
ISPARTA
DENİZLİ
MUĞLA
BURDUR
ANTALYA
G.ANTEP
MERSİN
ADANA
HATAY
OSMANİYE
MARDİN
K.MARAŞ
MALATYA
ADİYAMAN
Ş.URFA

ŞIRNAK
DİYARBAKIR
BATMAN
SİİRT
BİTLİS
ERZURUM
VAN
AĞRI
İĞDIR
ARDIHAN
ELAZIĞ
KARS
ERZİNCAN
TUNCELİ
BİNGÖL
AKSARAY
BEYŞEHİR
SEYDİŞEHİR
DİNAR
AYDIN

EDİRNE
KIRKLARELİ
TEKİRDAĞ
İSTANBUL
KOCAELİ
SAKARYA
YALOVA
BOLU
BURSA
BİLECİK
ESKİŞEHİR

KÜTAHYA
UŞAK
A.KARAHİSAR
YUNAK
AKŞEHİR
ÇELTİK
İLGİN
KADINHANI
SARAYÖNÜ
ANKARA
POLATLI
SUHUT

BORU ÇAPINA GÖRE SPRİNK HESAPLAMA

Ø 50 YAĞMURLAMA BORUSU

TEKNİK ÖZELLİKLER / TECHNICAL DATA

Nozul Ölçüleri	5 mt		6 mt		SPRİNK (adet)
	BORU (adet)	MESAFE (mt)	BORU (adet)	MESAFE (mt)	
6.0x5.0	6	30	6	36	3
6.0x4.0	8	40	8	48	4
5.0x5.0	8	40	8	48	4
5.0x4.2	10	50	10	60	5
5.0x3.8	12	60	12	72	6
5.0x2.5	14	70	14	84	7
4.5x4.2	12	60	12	72	6
4.5x2.5	12	60	12	72	6
4.5x3.8	14	70	14	84	7
4.2x3.8	12	60	12	72	6
3.8x2.5	16	80	16	96	8
3.8x2.3	16	80	16	96	8
3.5x2.5	24	120	24	144	12
3.2x1.8	26	130	26	156	13
2.5x2.5	26	130	26	156	13
2.5x1.8	34	170	34	204	17

Ø 63 YAĞMURLAMA BORUSU

TEKNİK ÖZELLİKLER / TECHNICAL DATA

Nozul Ölçüleri	5 mt		6 mt		SPRİNK (adet)
	BORU (adet)	MESAFE (mt)	BORU (adet)	MESAFE (mt)	
6.0x5.0	12	60	12	72	6
6.0x4.0	14	70	14	84	7
5.0x5.0	14	70	14	84	7
5.0x4.2	16	80	16	90	8
5.0x3.8	18	90	18	108	9
5.0x2.5	20	100	20	120	10
4.5x4.2	18	90	18	108	9
4.5x2.5	20	100	20	120	10
4.5x3.8	22	110	22	132	11
4.2x3.8	20	100	20	120	10
3.8x2.5	24	120	24	144	12
3.8x2.3	24	120	24	144	12
3.5x2.5	36	180	36	216	18
3.2x1.8	40	200	40	240	20
2.5x2.5	40	200	40	240	20
2.5x1.8	50	250	50	300	25

BORU ÇAPINA GÖRE SPRİNK HESAPLAMA

Ø 75
YAĞMURLAMA
BORUSU

TEKNİK ÖZELLİKLER / TECHNICAL DATA

Nozul Ölçüleri	5 mt		6 mt		SPRİNK (adet)
	BORU (adet)	MESAFE (mt)	BORU (adet)	MESAFE (mt)	
6.0x5.0	20	100	20	120	10
6.0x4.0	20	100	20	120	10
5.0x5.0	22	110	22	132	11
5.0x4.2	28	140	28	165	14
5.0x3.8	30	150	30	180	15
5.0x2.5	30	170	30	204	17
4.5x4.2	32	160	32	192	16
4.5x3.8	32	160	32	192	16
4.2x3.8	32	160	32	192	16
3.8x2.5	42	210	42	252	21
3.8x2.3	42	210	42	252	21
3.5x2.5	60	300	60	360	30
3.2x1.8	66	330	66	396	33
2.5x2.5	66	330	66	396	33
2.5x1.8	84	420	84	504	42

Ø 90
YAĞMURLAMA
BORUSU

TEKNİK ÖZELLİKLER / TECHNICAL DATA

Nozul Ölçüleri	5 mt		6 mt		SPRİNK (adet)
	BORU (adet)	MESAFE (mt)	BORU (adet)	MESAFE (mt)	
6.0x5.0	34	170	34	204	17
6.0x4.0	36	180	36	216	18
5.0x5.0	36	180	36	216	18
5.0x4.2	42	210	42	525	21
5.0x3.8	50	250	50	300	25
5.0x2.5	56	280	56	336	28
4.5x4.2	48	240	48	288	24
4.5x3.8	52	260	52	312	26
4.2x3.8	52	260	52	312	26
3.8x2.5	72	360	72	432	36
3.8x2.3	74	370	74	444	37
3.5x2.5	96	480	96	576	48
3.2x1.8	106	530	106	636	53
2.5x2.5	106	530	106	636	53
2.5x1.8	130	650	130	780	65

3'LÜ SİSTEM HESAPLAMA

1/2 SPRİNK İLE ABOT ÜSTÜ DAĞTICILI SİSTEM

ABOT UPPER DISTRIBUTED SYSTEM WITH 1/2 SPRİNK

1000 m² 3'LÜ ABOT ÜSTÜ DAĞTICILI SİSTEM

1000 m² ABOT UPPER DISTRIBUTOR 3 SYSTEM

ÜRÜN	ANA BORU (5cm)		ANA BORU (6cm)		ANA BORU (6cm)	
	LATEREL BORU (5cm)		LATEREL BORU (5cm)		LATEREL BORU (6cm)	
	SİSTEM KURULUMU (10 x 10)		SİSTEM KURULUMU (12 x 10)		SİSTEM KURULUMU (12 x 12)	
LATERAL BOR(MANDALLI BORU)	6,6	ADET	5,6	ADET	4,6	ADET
ABOT	3,3	ADET	2,8	ADET	2,3	ADET
1/2" SPRİNK	10	ADET	8,5	ADET	7	ADET
UZATMA BORUSU	3,3	ADET	2,8	ADET	2,3	ADET
32'LİK KÜRESEL VANA	3,3	ADET	2,8	ADET	2,3	ADET
ABOT ÜSTÜ İSTAVROZ	3,3	ADET	2,8	ADET	2,3	ADET
MİNİ SİPRİNK ADAPTÖR	6,6	ADET	5,6	ADET	2,3	ADET
32X20 MANŞON	3,3	ADET	2,8	ADET	4,6	ADET
8mm GALVANİZLİ MİL	6,6	ADET	5,6	ADET	2,3	ADET
YUVARLAK DÜZ BORU	73	METRE	73	METRE	60	METRE

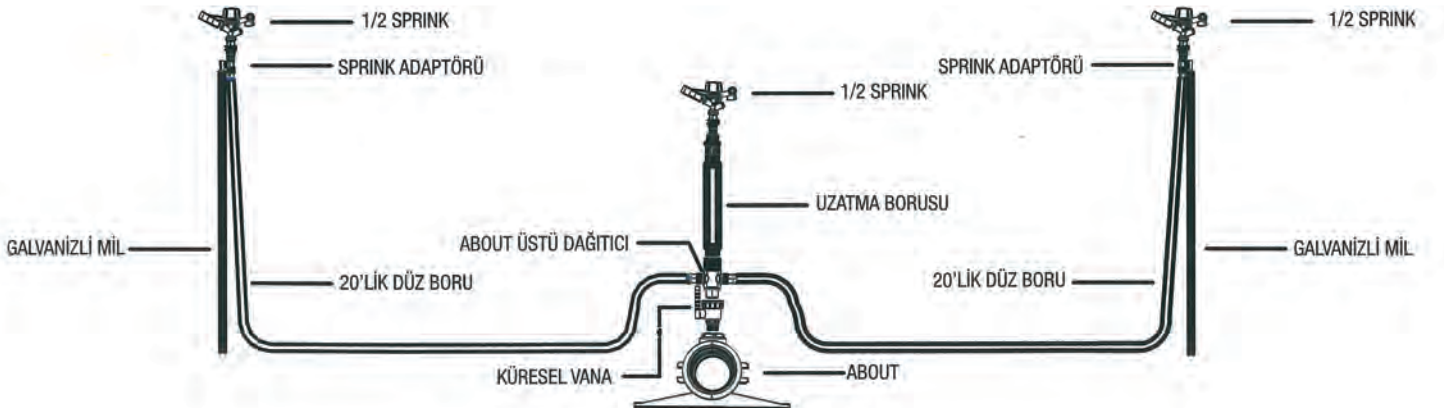

5'Lİ SİSTEM HESAPLAMA

1/2 SPRİNK İLE ABOT ÜSTÜ DAĞTICILI SİSTEM

ABOT UPPER DISTRIBUTED SYSTEM WITH 1/2 SPRİNK

1000 m² 5'Lİ ABOT ÜSTÜ DAĞTICILI SİSTEM

1000 m² ABOT UPPER DISTRIBUTOR 5 SYSTEM

ÜRÜN	ANA BORU (5cm)		ANA BORU (6cm)		ANA BORU (6cm)	
	LATEREL BORU (5cm)		LATEREL BORU (5cm)		LATEREL BORU (6cm)	
	SİSTEM KURULUMU (10 x 10)		SİSTEM KURULUMU (12 x 10)		SİSTEM KURULUMU (12 x 12)	
LATERAL BOR(MANDALLI BORU)	4	ADET	3,4	ADET	4,6	ADET
ABOT	2	ADET	1,7	ADET	2,3	ADET
1/2" SPRİNK	10	ADET	8,5	ADET	7	ADET
UZATMA BORUSU	2	ADET	1,7	ADET	2,3	ADET
32'LİK KÜRESEL VANA	2	ADET	1,7	ADET	2,3	ADET
ABOT ÜSTÜ İSTAVROZ	2	ADET	1,7	ADET	2,3	ADET
MİNİ SİPRİNK ADAPTÖR	8	ADET	6,8	ADET	4,6	ADET
32X20 MANŞON	2	ADET	1,7	ADET	2,3	ADET
8mm GALVANİZLİ MİL	4	ADET	6,8	ADET	4,6	ADET
SOMUNLU TE	4	ADET	3,4	ADET	2,8	ADET
8mm GALVANİZLİ MİL	88	METRE	88,5	METRE	74	METRE

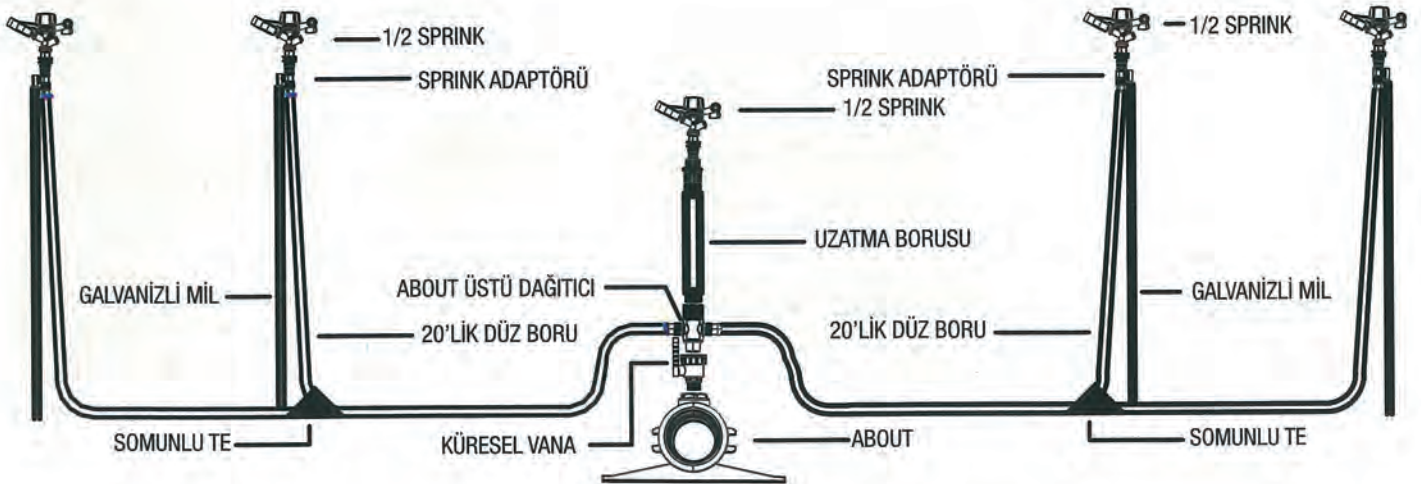

KALİTE BELGELERİMİZ QUALITY CERTIFICATE

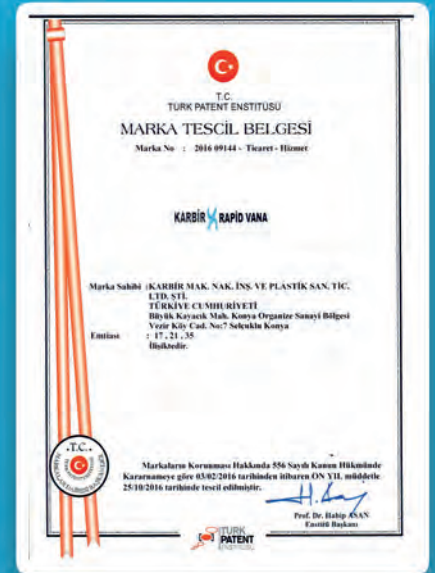

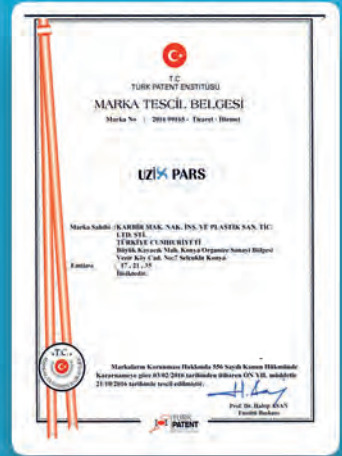

YÜKLEME DETAYLARI



Koli Tipi Box Type	En (cm) With (cm)	Boy (cm) Length (cm)	Yükseklik (cm) Height (cm)
-----------------------	----------------------	-------------------------	-------------------------------

A-1	34	46	33
------------	-----------	-----------	-----------

A-2	50	66	30
------------	-----------	-----------	-----------

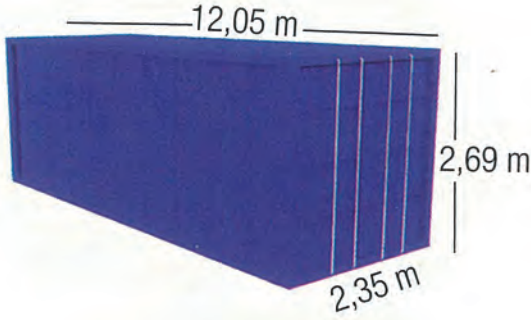

Box - 1	Adet
40"HC	1250

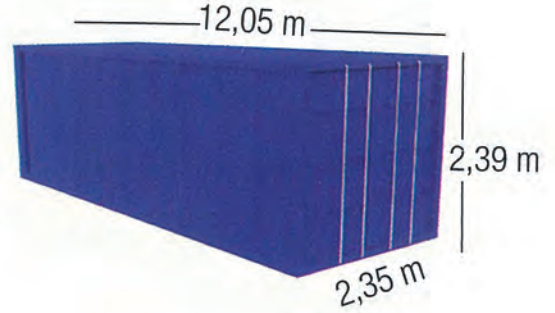

Box - 1	Adet
40"DC	1512

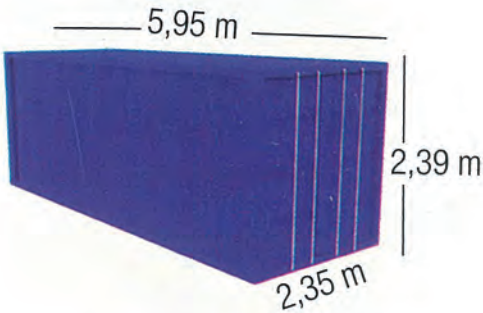

Box - 1	Adet
20"DC	600



Box - 1	Adet
TRUCK	1624

KARBİR® 
P L A S T İ K

SINCE 1996



bilgi@karbir.com.tr

Telefon: +90 332 346 06 03-04

Faks: +90 332 346 06 05

2. Organize Sanayi Bölgesi Büyük Kayacık Mah.
Vezirköy Cad. No:7 Selçuklu / KONYA